

# Manitowoc Cranes

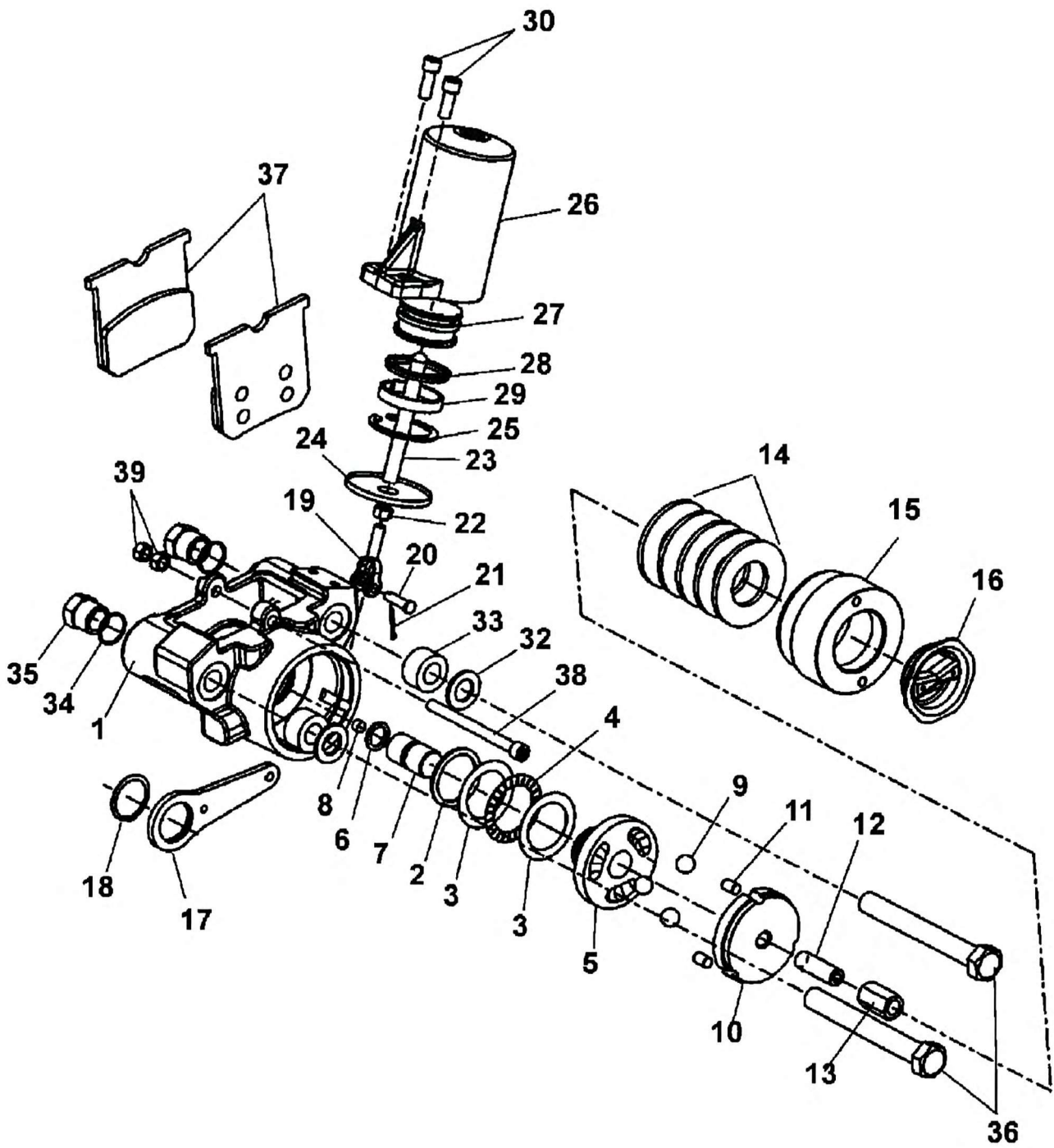

80022000

(SHEET 1 OF 1)

Page 564